

# Storage Cabinet Option

If you like the look of the file cabinet but don't need the file drawers, you can convert it to a cabinet with a slim top drawer and a storage compartment below. In this configuration, it works well as a bedside table or lamp table in the living room. The basic construction is the same.

You'll build the case, top, and applied mouldings using the same techniques as shown for the original design. Even the false drawer fronts use the same process. They're just sized to match the door and smaller drawer. I'll point out the differences in the design and you can follow them in the illustrations

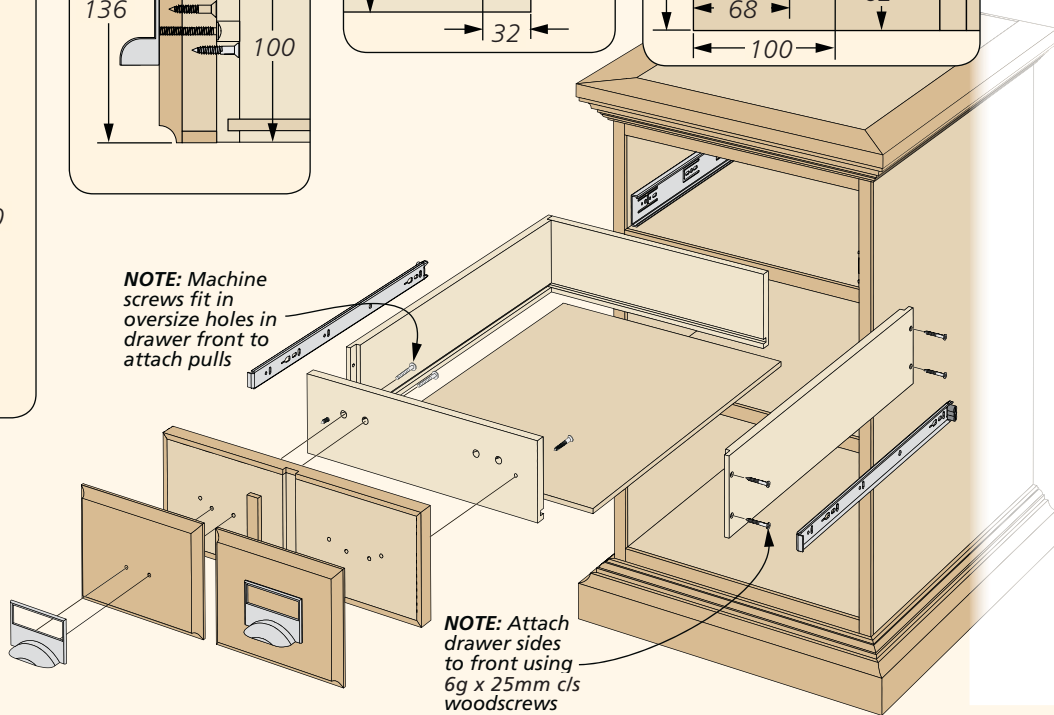
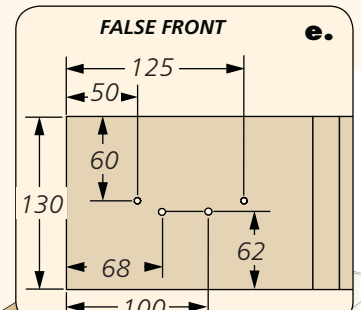
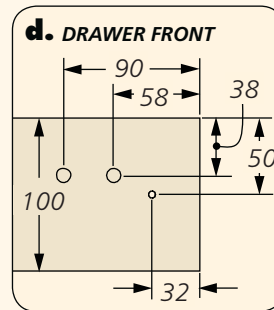
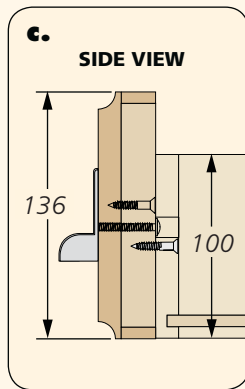
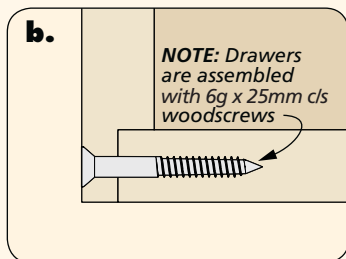
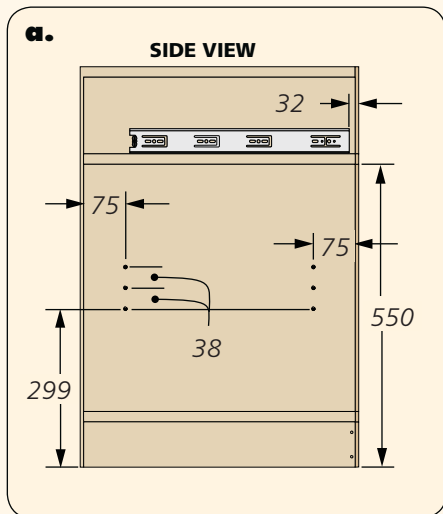
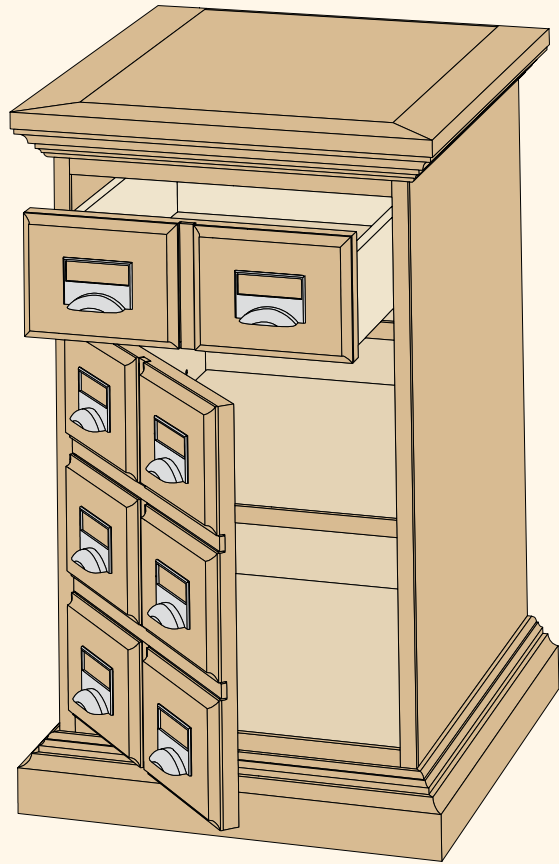

**THE CASE.** The first adjustment you'll need to make is the placement of the trenches in the sides. Detail 'a' on the opposite page shows where to position the trench to hold the divider and the holes for the shelf pins that will support the adjustable shelf below.

The rest of the case remains true to the original design. You can continue to add the edging, the base mouldings and the top as shown in the published plan.

**A SMALLER DRAWER.** The drawer is assembled with rebate joints reinforced with screws. The bottom fits into a groove in the front, back, and sides. The length and width of the drawer are the same as the large file drawers in the original plan. You can see the dimensions that require adjustment for this version in details 'c,' 'd,' and 'e' on the opposite page. Assembly and installation are unchanged from the plan.

**THE LOWER COMPARTMENT.** The drawing at right shows how the cabinet door fits on the case to cover the lower storage area and adjustable shelf. You can get started by cutting the shelf to size and adding edging to the plywood.

**THE DOOR.** Though the dimensions are different, the door is just like the drawer fronts in the original plan. After cutting the plywood panel to size, you'll need to cut two trenches and a centred groove to divide the panel into six fields. Then it's just a matter of adding the filler strips and false fronts using the same method as the shown in the published plan.

**HINGES.** I chose a Euro-style hinge for the cabinet door. They're pretty straightforward to install and they allow you to make final adjustments after everything's assembled. That means getting a perfect fit is a breeze. You can see how they attach in details 'a' and 'b'. You'll need to use a 35mm Forstner bit to get a perfect fit for the hinge cups.

**ADD A CATCH.** To complete the cabinet, all you need to do is attach a magnetic catch to the door. The drawing above and detail 'c' give you the information for placing the catch and strike plate.

